

WINTER RANGE TRIBUTE MATCH

As you probably know, the 2021 Winter Range was to be the last Winter Range but it has been cancelled due to COVID. As a tribute the following twelve stages are based on the 2018 Winter Range stages and are modified to fit our range as well as reduce the amount of steel that has to be staged. It will give you 80% of what the real Winter Range stages feel like.

It is a good match for anybody that has not been to Winter Range but would like to know what the shoot is like.

Score keepers should note that the stages are not shot in sequence since the stages had to be made to fit our range.

BAY 1 - STAGE 3-Livery

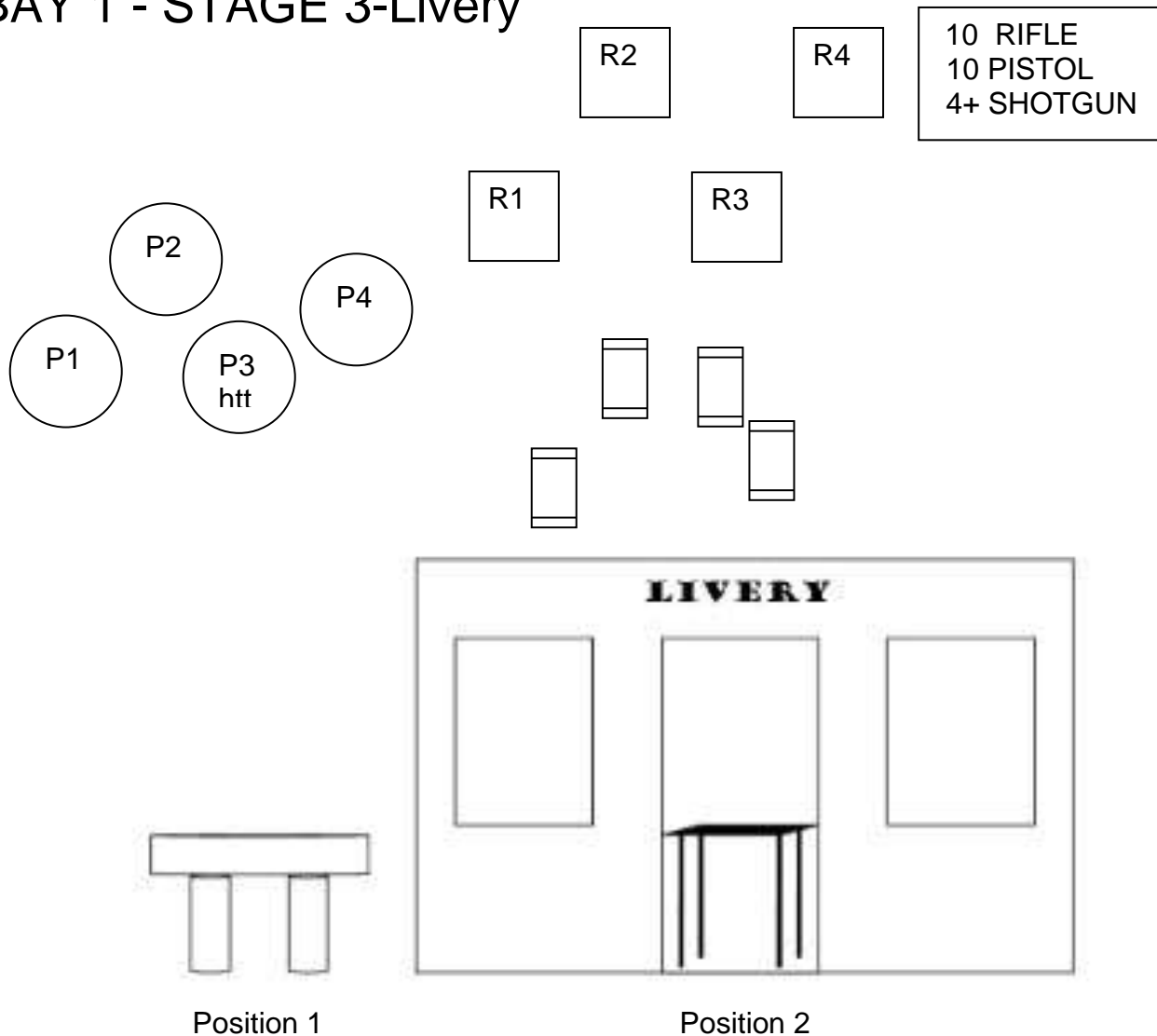

Start position: Shooter standing at position 1 or position 2 with hands at SASS default. Open empty shotgun and Rifle loaded with 10 rounds staged anywhere safely. Pistols loaded 5 rounds each holstered. Stage may be engaged either left to right or right to left. Guns may be shot in any order but rifle may not be last.

On signal: If with shotgun, from position 2 engage the 4 shotgun targets any order. Must go down. Make shotgun safe.

From position 2, with rifle, engage R1-R4 with a continuous Nevada sweep in either direction. Make rifle safe.

From position 1, with revolvers engage P1-P4 with a continuous Nevada sweep in either direction.

BAY 5 - STAGE 2 - Restaurant

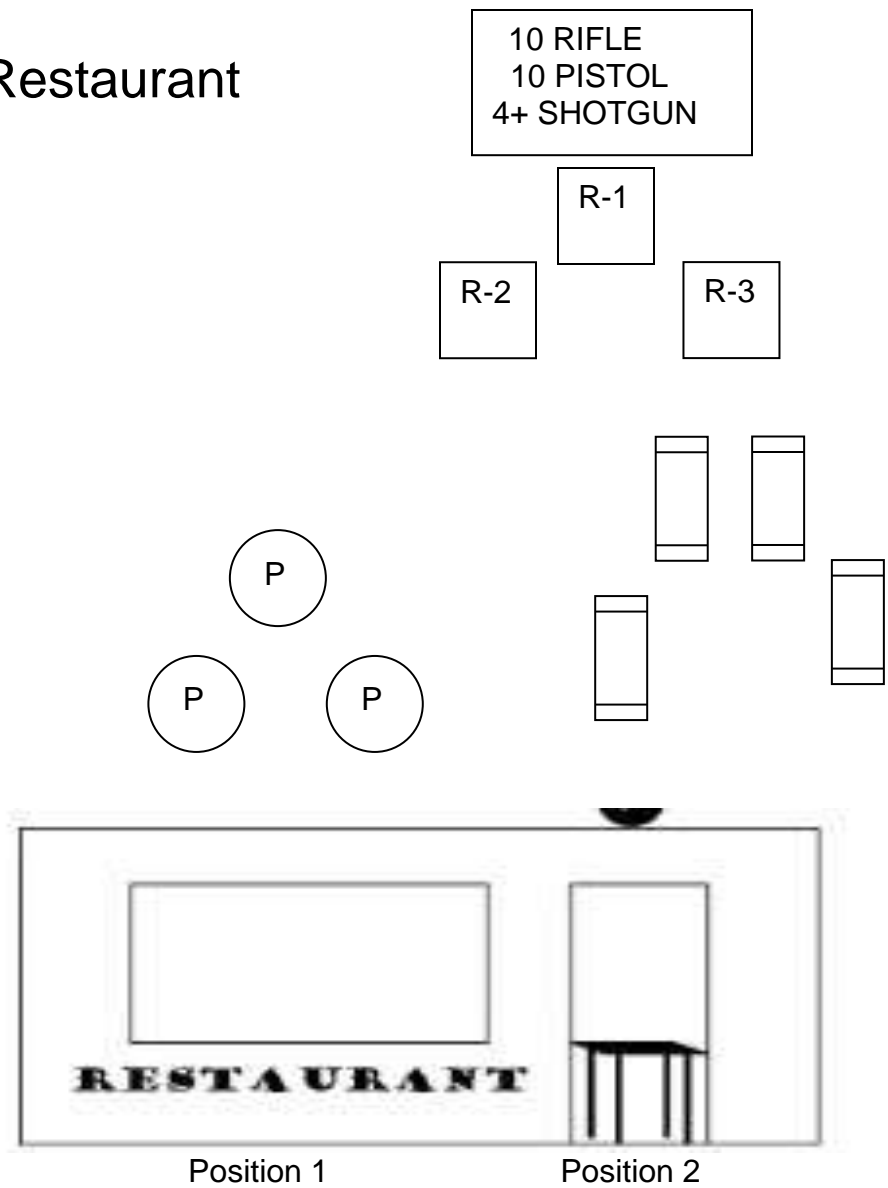

Staging: Shooter standing at SASS default. Rifle loaded with 10 rounds and open empty shotgun staged anywhere safely. Pistols loaded with 5 rounds each holstered. Firearms may be used in any order, but rifle must not be last. Stage may be engaged left to right or right to left. Shooter indicates ready by saying "Faster than you'll ever be"

At the beep, - if from position 2, with rifle alternate between R-1 and either R-2 or R-3 for 5 rounds starting on either. Repeat the instruction using R-1 and the other R target for the next 5 rounds. From position 2, with shotgun engage the four "s" targets, must go down. From position 1, with pistols, engage the "P" targets as per the rifle instructions..

BAY 3-STAGE 6

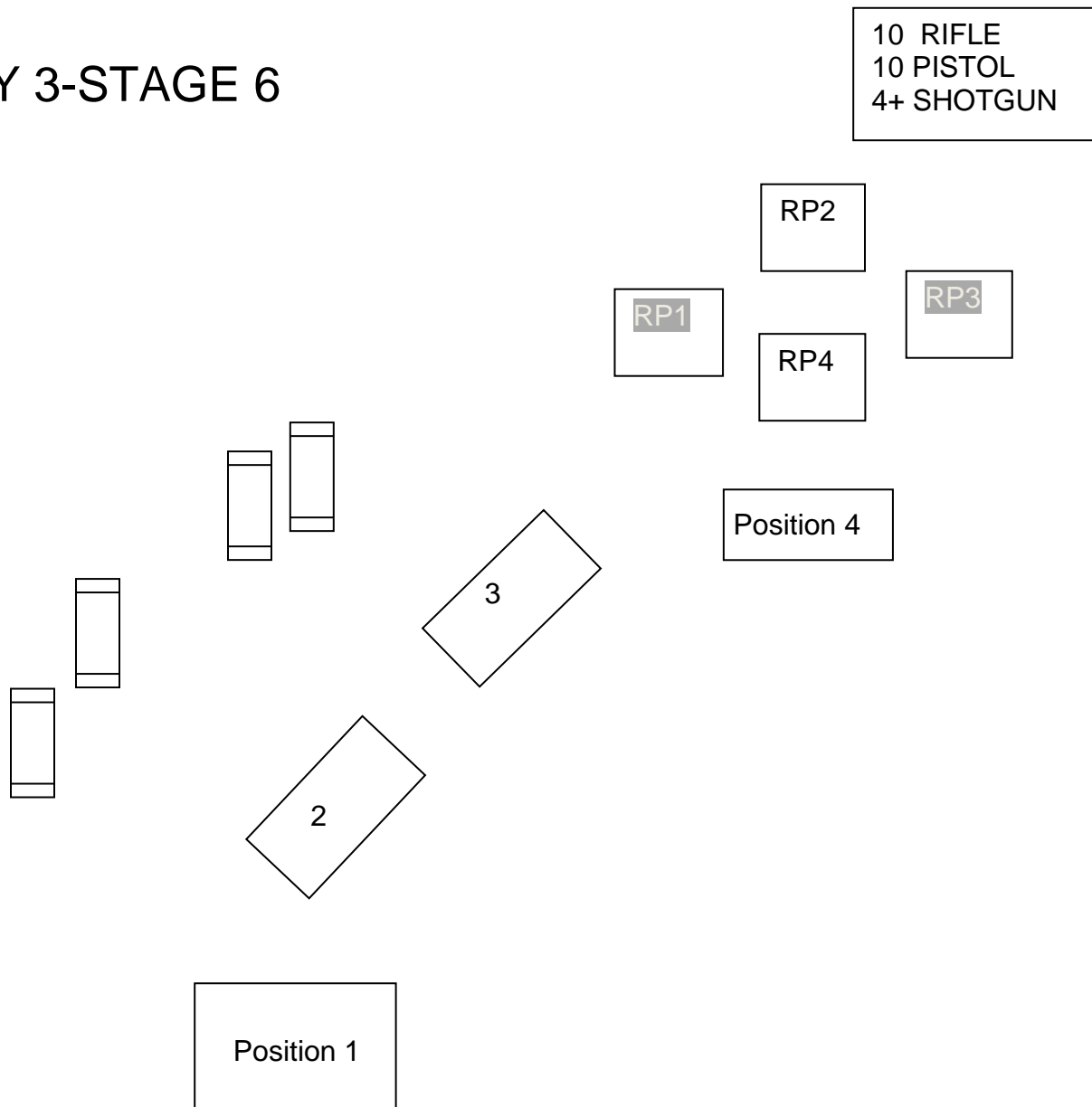

Start: At position 1, rifle loaded with 10 rounds in hands. Open and empty shotgun staged anywhere safely. Two revolvers loaded with 5 rounds each, holstered.

At the buzzer: From position 1 with rifle engage either R-1 or R-3 twice then sweep from bottom to top or top to bottom using the target you double tapped as the center target for the first five rounds. Repeat the instruction using the other target for the second 5 rounds.. Make rifle safe between rails pointing into the berm. Retrieve shotgun and engage 4 shotgun targets from 2 positions. Make shotgun safe at position 3. With revolvers from position 4, engage RP1 – RP4 as per the instructions for the rifle.

Note: Shotgun make ups must be made up at that position. Once you move forward, you may not return or shoot the targets behind you. Shotgun positions are defined as “within one step of the hay bales with the shot going over the top of the hay bales.

BAY 4 - STAGE 1 - Bordello

10 RIFLE
10 PISTOL
6+ SHOTGUN

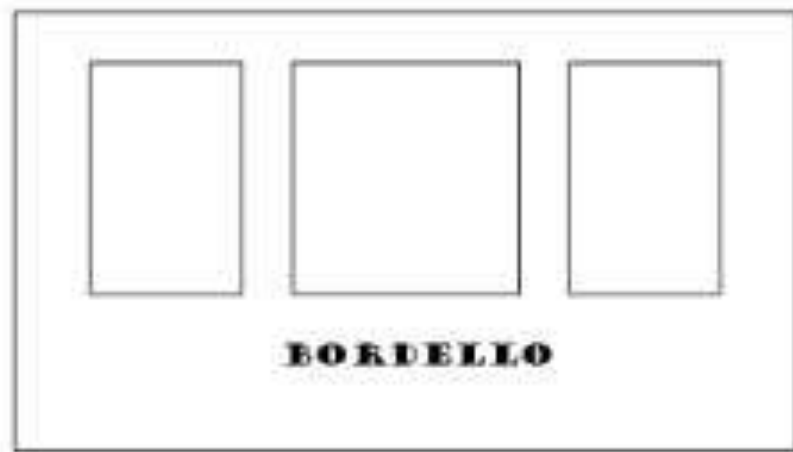
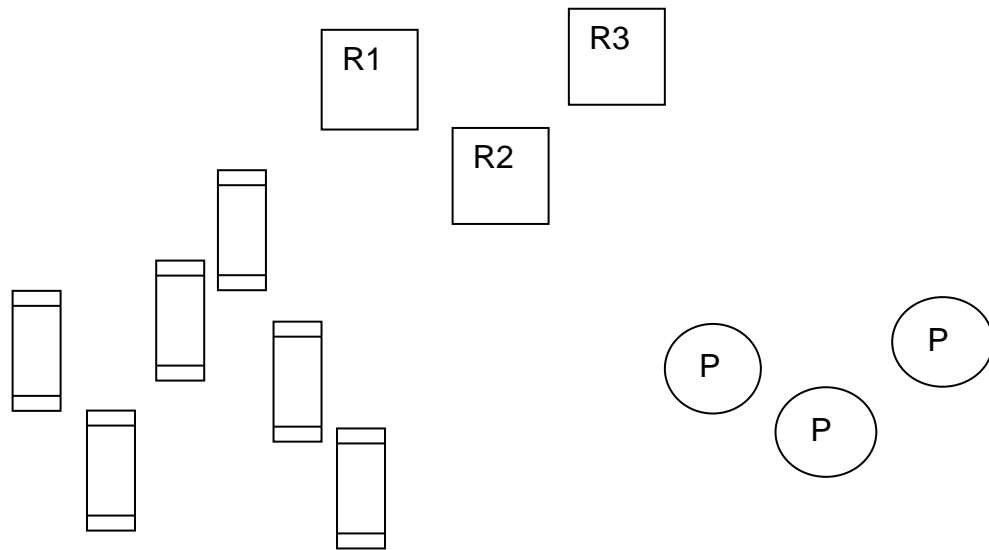

Position 1

Position 2

Position 3

Start: At position 1 or position 3 at SASS default. Rifle loaded 10 rounds and open, empty shotgun staged anywhere safely. Two revolvers loaded with 5 rounds each, holstered.

When ready say, ***"I'll kill every man in Lago!"***. Wait for the buzzer.

At the beep, From position 1 with shotgun engage the six "S" targets in front, must go down. From Position 2, with rifle, engage the R targets with a "Nine Toe Joe Shuffle" (Left outside, right outside, left outside, right outside, center) starting on either end for the first 5 rounds. Repeat the instruction for the next 5 rounds.

From position 3, with pistols, engage the pistol targets as per the rifle instructions.

NOTE: Stage may be engaged either right to left or left to right.

BAY 6 – Stage 5 - Jail

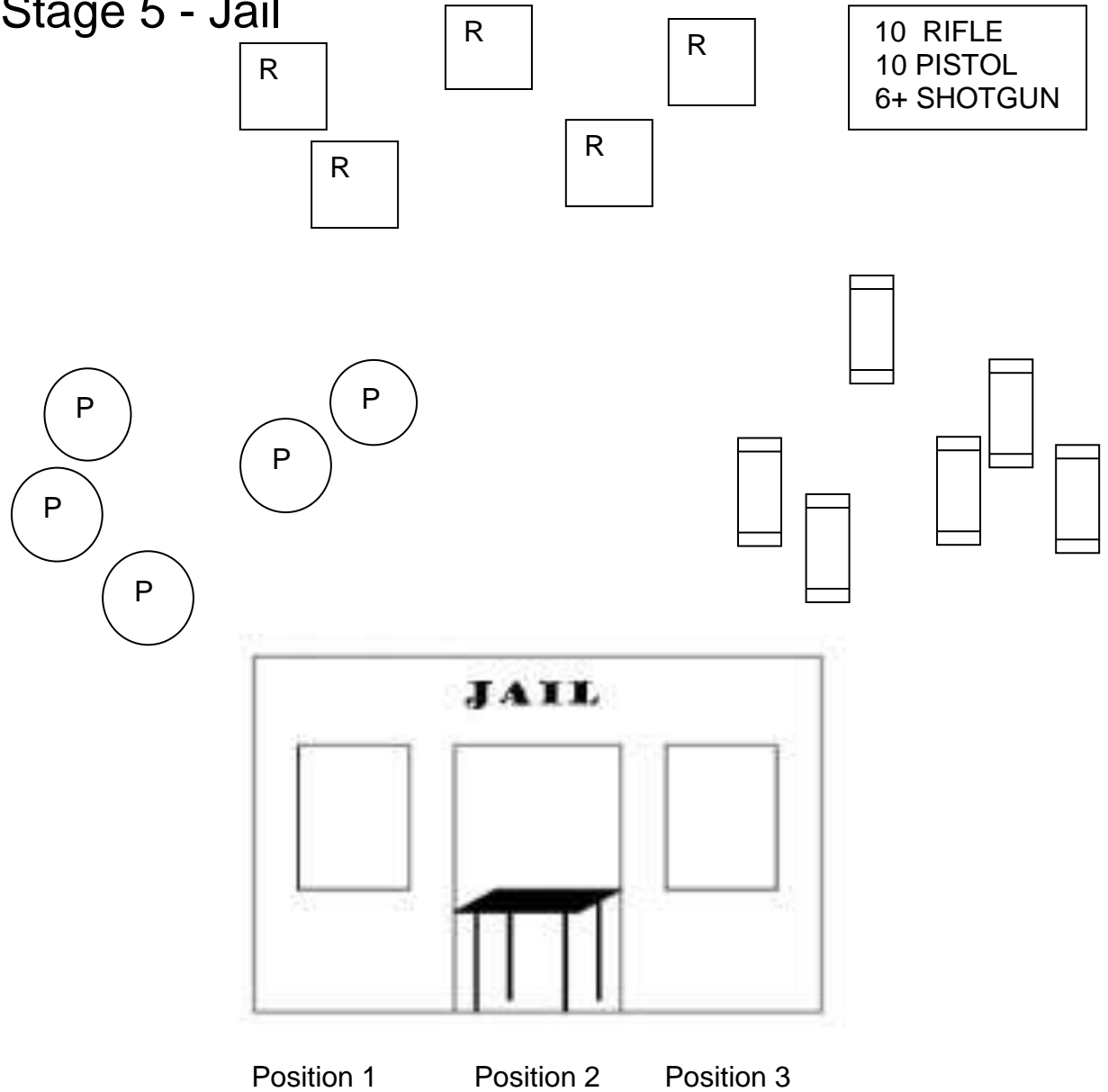

Start: At either POS 1 or POS 3, standing upright with hands on head or hat... Rifle loaded with 10 rounds and open, empty shotgun both staged anywhere safely. Two revolvers loaded with 5 rounds each, holstered. Stage may be engaged from left to right or right to left.

At the beep if From position 1, with revolvers double tap the 5 P targets.

From position 2, with rifle double tap the 5 R targets.

From position 3, with shotgun, engage the 6 shot gun targets. Must go down.

BAY 7 - STAGE 4 - Saloon

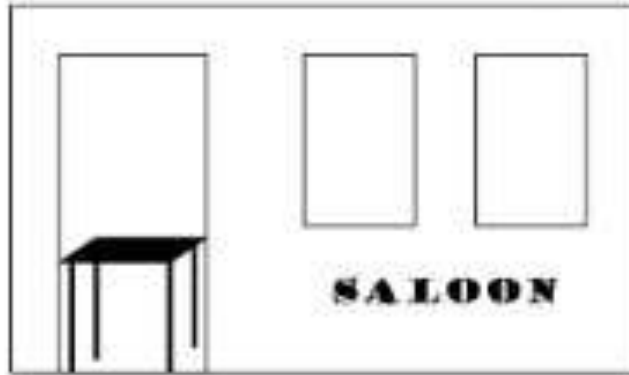
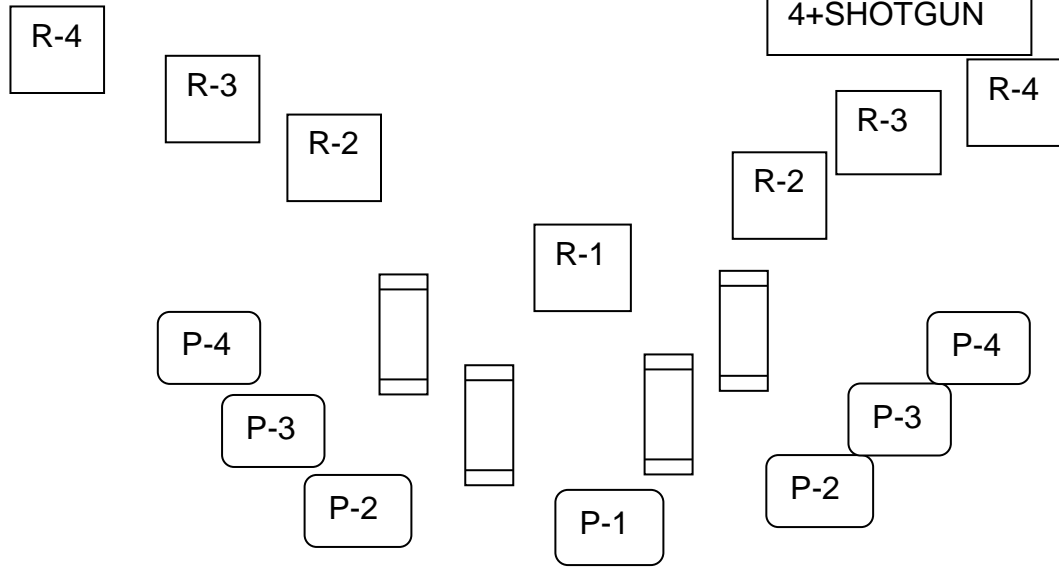

Position 1

Position 2

Position 3

Start: At POS 2, with first firearm(s) to be used in hand(s). Rifle loaded with 10 rounds and open, empty shotgun both staged anywhere safely. Two revolvers loaded with 5 rounds each, holstered or in hand(s). Revolvers may be either holstered or restaged on the table after use. Firearms may be used in any order, but rifle may not be last. Shooter indicates ready by saying "you may need me and this Winchester, Curly!"

At the buzzer, with shotgun, engage the 4 shotgun targets. Any order. Must go down. Make shotgun safe.

From position 2, with rifle, engage R1 twice, then sweep either side (R2-R4) for the first 5 rounds. Then engage R1 twice and sweep the other side (R2-R4) for the second 5 rounds..

From position 2, with pistols, engage revolver targets as per the rifle instructions.

Bay 1 - STAGE 8 - Livery

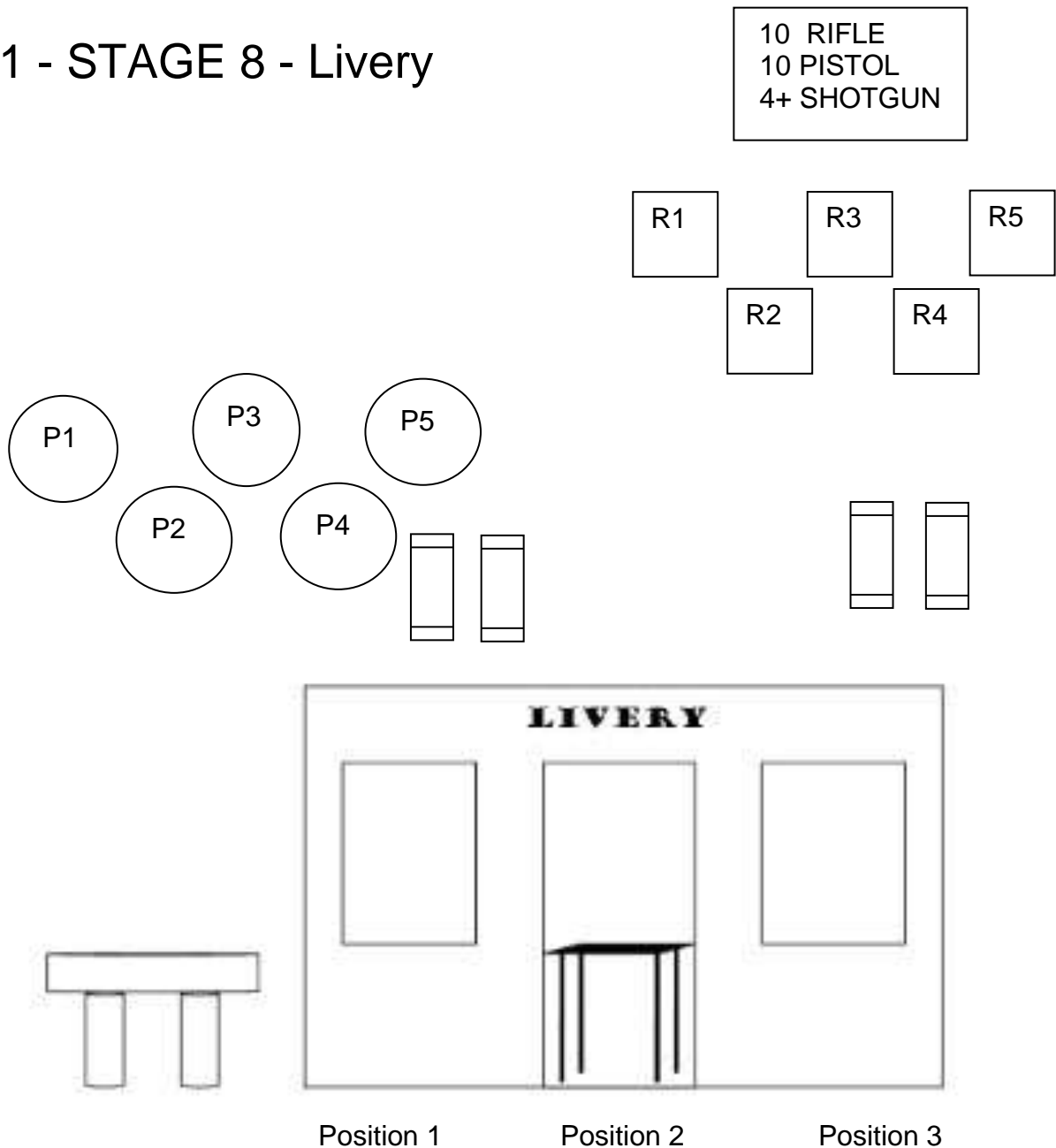

Start: At POS 3 standing upright with hands at low surrender (hands at least shoulder high). Rifle loaded with 10 rounds and open, empty shotgun staged anywhere safely. Two revolvers loaded with 5 rounds each, holstered. Shooter indicates ready by saying "Next time you shoot somebody, don't go near 'em 'til you're sure they're dead!".

On Signal: From POS 3 with rifle shoot a "W" sweep from either end twice in the same direction (no dirty sweeps) then with shotgun engage the two "Shotgun" targets – must go down.

Then move to position 1 engage the other two "Shotgun" targets. With revolvers engage pistol targets same as the rifle instructions

BAY 3 - STAGE 7

10 RIFLE
10 PISTOL
2+ SHOTGUN

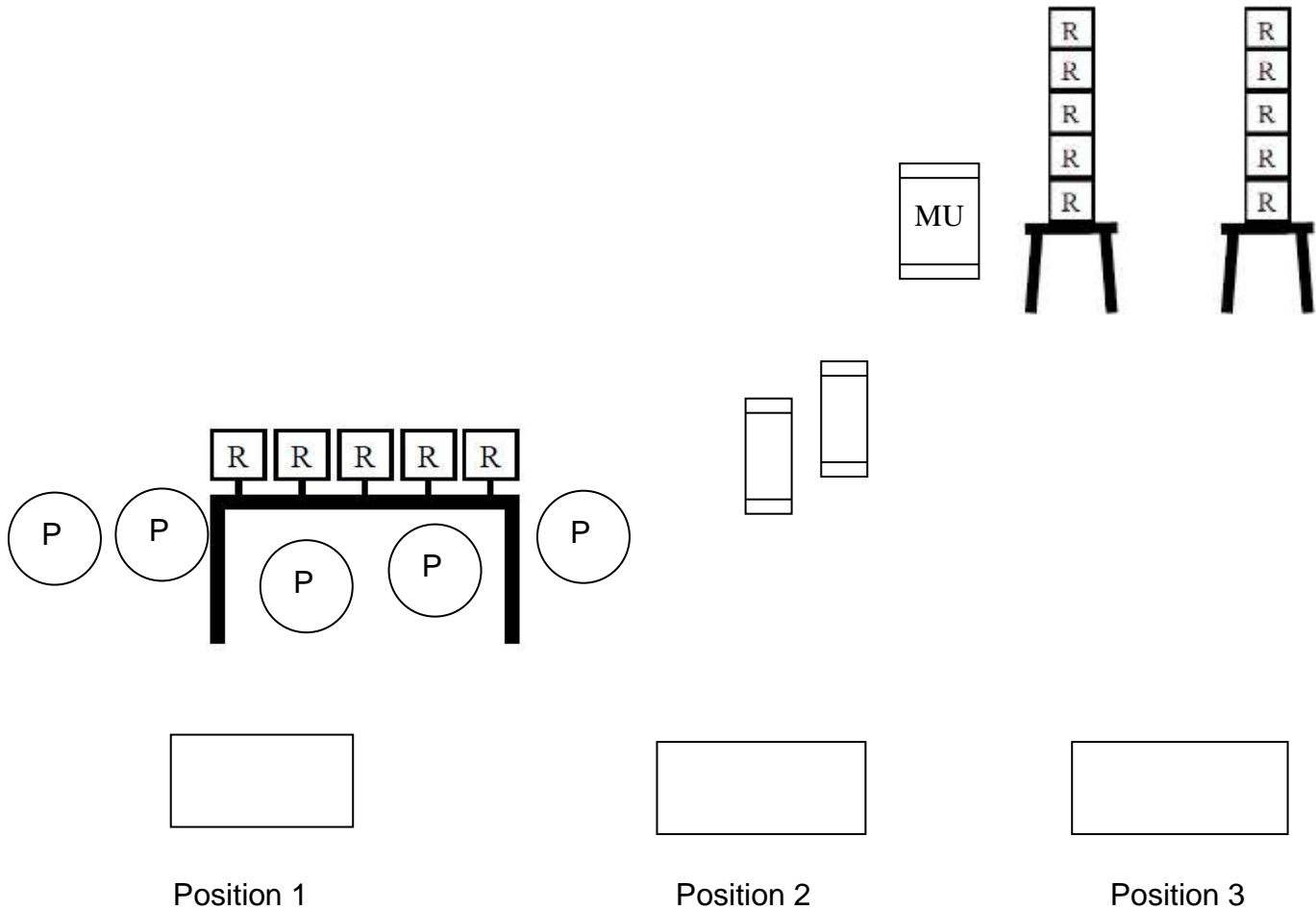

Start: At position 1 standing with one hand on a make believe bible and the other hand as taking an oath. Rifle loaded with 10 rounds and open, empty shotgun both staged anywhere safely. Two revolvers loaded with 5 rounds each, holstered..

At the buzzer, From POS 1 with revolvers engage the 5 plates on the rack and the five "P" targets once each. Targets may be shot in any order. .Move to Position 3 and with rifle engage the 10 tomstone plates (on two racks) once each. Move to Position 2 and with shotgun engage the two "S" targets. THEN make up any standing plates with the shotgun by ingaging the "MU" target once for each plate standing.

NOTE: Any knockdown plates left standing and not made up will be counted as misses. You do not have to hit the MU target for the make-up shots to count.

BAY 4 - STAGE 9 - Bordello

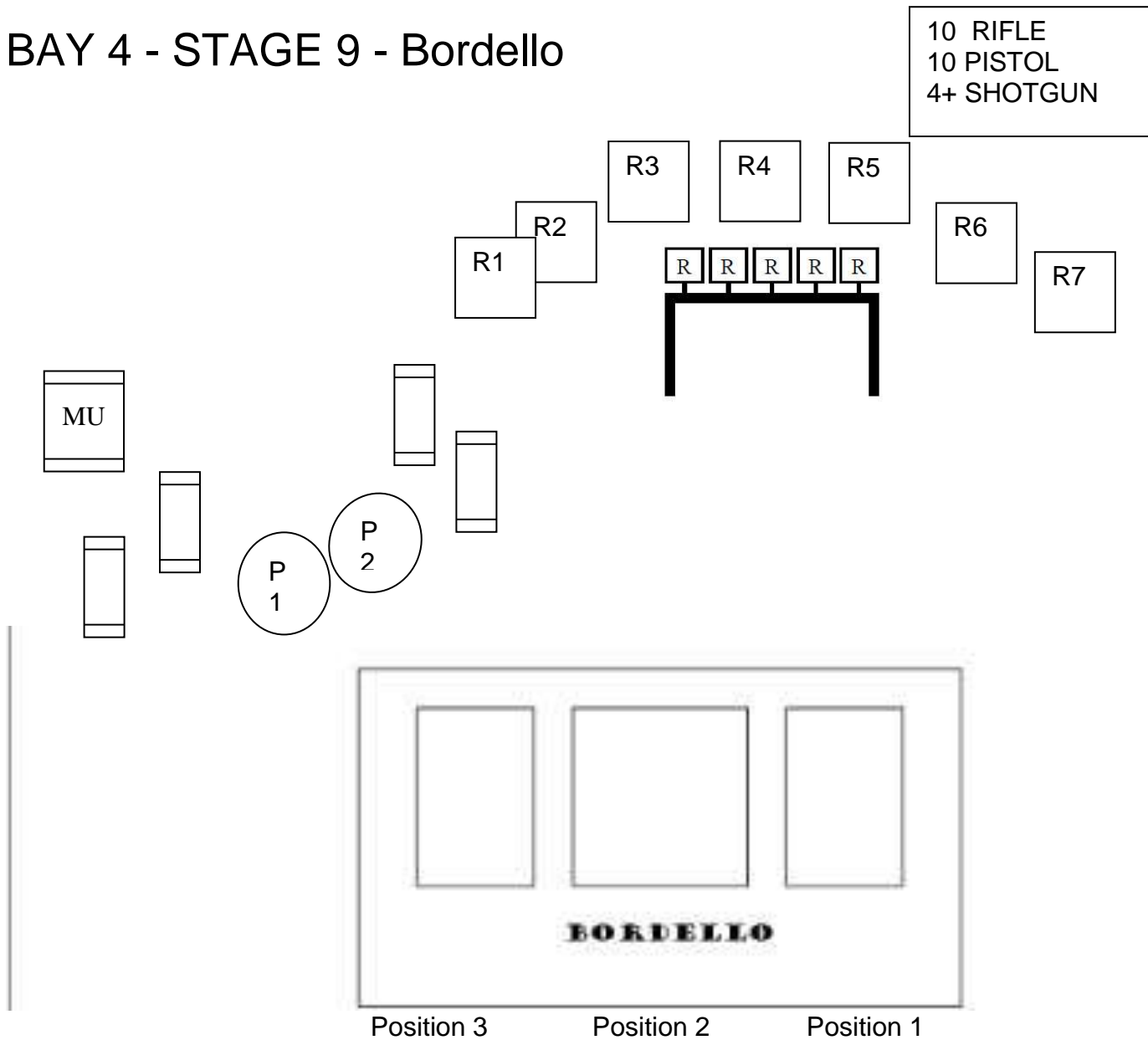

Start: At POS 1 standing upright with right hand raised (with four fingers extended). Rifle loaded with 10 rounds and open, empty shotgun both staged anywhere safely. Two revolvers loaded with 5 rounds each, holstered. Shooter may indicate ready by saying “My mistake,four coffins!”

At the buzzer With rifle engage seven “R” targets once each and three plates on the rack once each..

From position 3 with revolvers engage the two “P” targets 5 time each for 10 rounds.

From position 3, with shotgun, engage the four shotgun targets any order. Must go down. Then make up any plates left standing by engaging the MU target once for each plate standing.

Note: At position 3 either the shotgun or the revolvers may be shot first. Any plates left standing and not made up will be counted as misses. You do not need to hit the MU target for the make up shots to count.

BAY 5 -STAGE 11 -Restaurant

10 RIFLE
10 PISTOL
4+ SHOTGUN

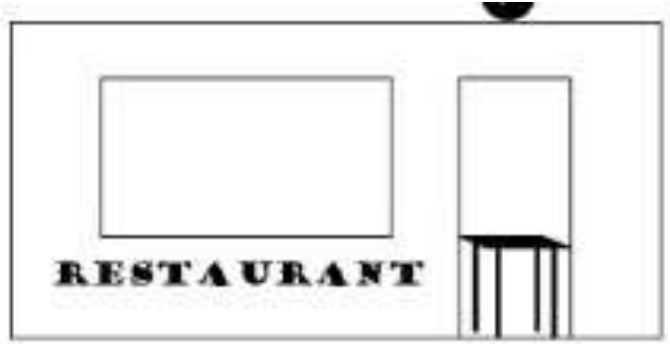
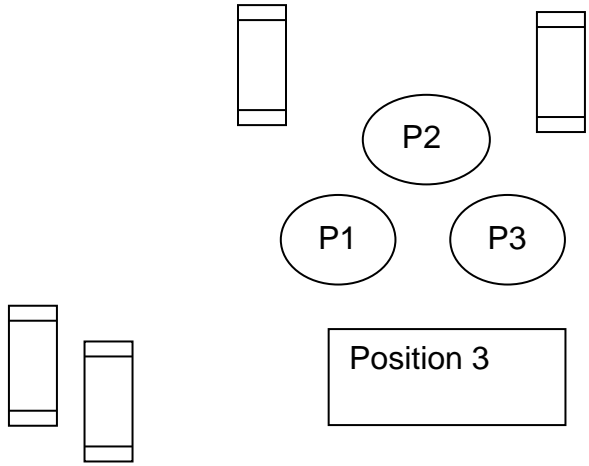
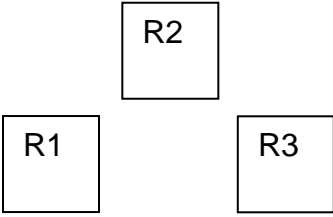

Position 1

Position 2

Start: Shooter standing at position 1 Rifle loaded with 10 rounds in hand. Open empty shotgun staged anywhere safely except at position 3. Pistols loaded with 5 rounds each holstered.

When ready say, **"Alive or dead – it's your choice"** Wait for the buzzer

At the buzzer, With Rifle engage R1-R3 at least three times each, any order. Make Rifle safe vertically. From POS 2R with shotgun engage the two "Shotgun" targets. Move to POS 3 and engage 2 shotgun targets, must go down With revolvers engage P1-P3 as per the rifle instructions

BAY 6 -STAGE 12 - Jail

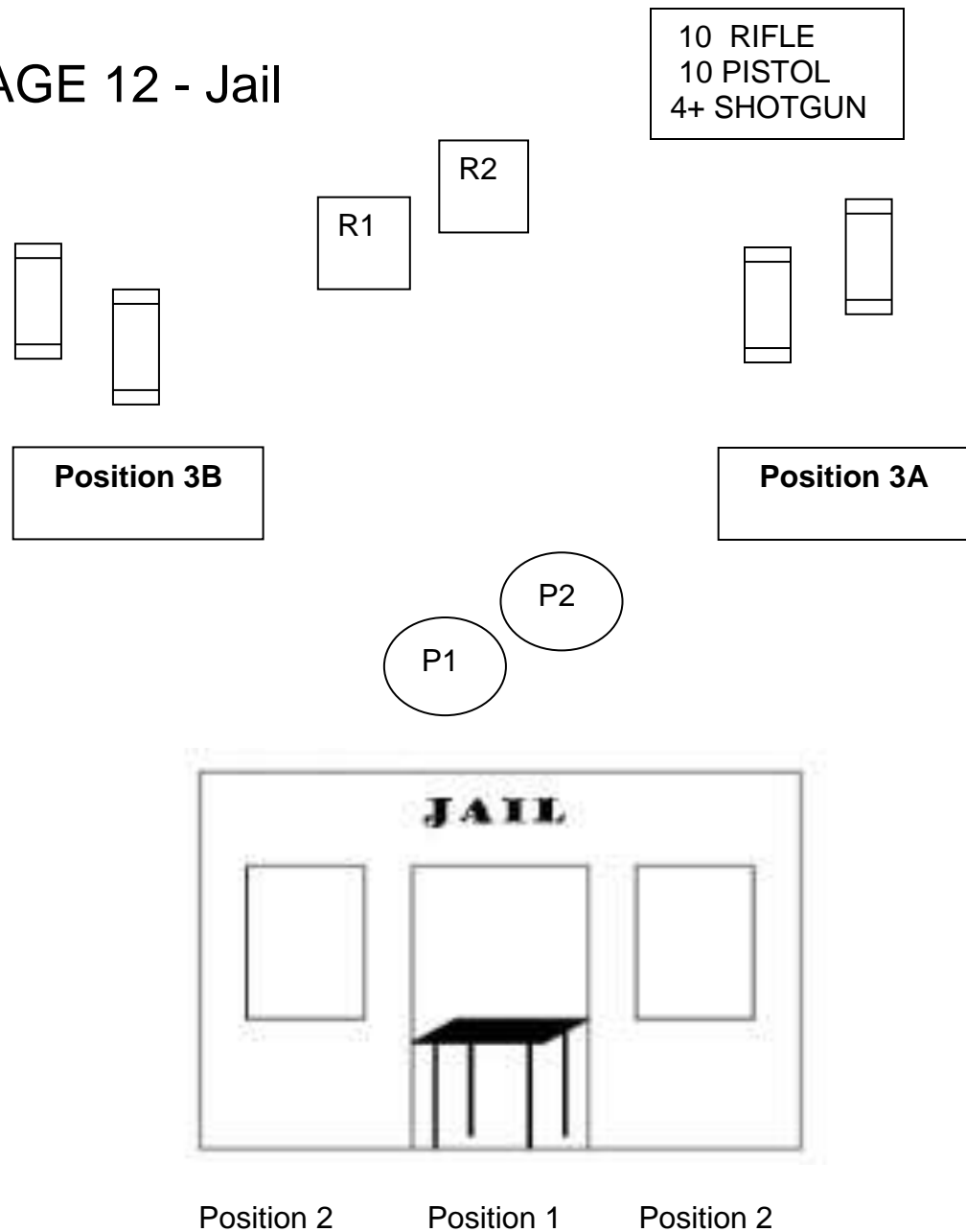

Start: At Position 1 standing upright with hand(s) touching revolver(s), Two revolvers loaded with 5 rounds each, holstered, rifle loaded 10 and open empty shotgun staged anywhere safely except at a position 3.

At the buzzer engage P1-P2 with a "Sweet Lil" Sweep" (1 on P1, 2 on P2, 4 on P1, 2 on P2, 1 on P1). From either position 2 (windows) with rifle engage R1-R2 as per the revolver instructions. Make rifle safe vertically.

From one of the position 3s (hay bales) with shotgun engage two "S" targets must go down. Move to other position 3 and engage the remaining two "S" targets, must go down.

BAY 7 - STAGE 10 - Saloon

10 RIFLE
10 PISTOL
6+SHOTGUN

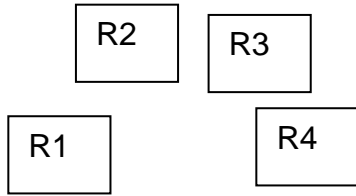

1

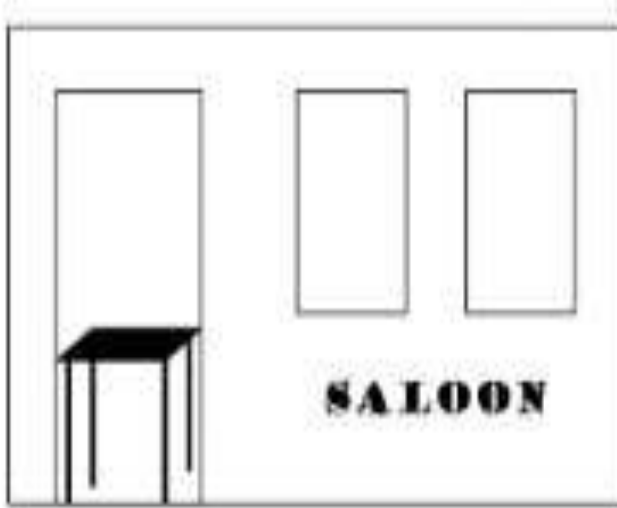
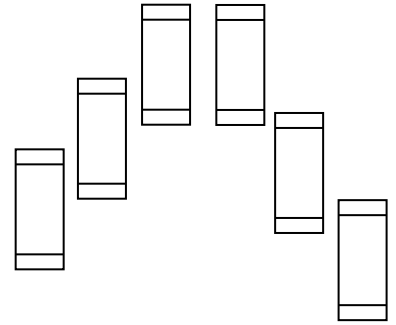
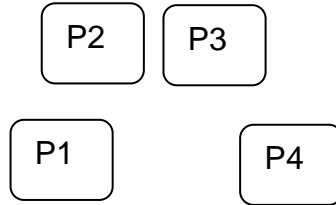

Position 1 Position 2 Position 3

Start: Shooter standing with hands at high surrender at position 1,. Rifle loaded with 10 rounds, open empty shotgun staged anywhere safely. Two revolvers loaded with 5 rounds each, holstered.

At the buzzer, with engage R1-R4 in a "Twister Sweep" (R1,R2,R3,R4,R2,R3,R1,R2,R3,R4) from either end. From position 2 with revolvers engage P1-P4 as per the rifle instruction. From position 3 with shotgun engage the six "S" targets, must go down..