

BAY 3 –Corner Bay STAGE 1

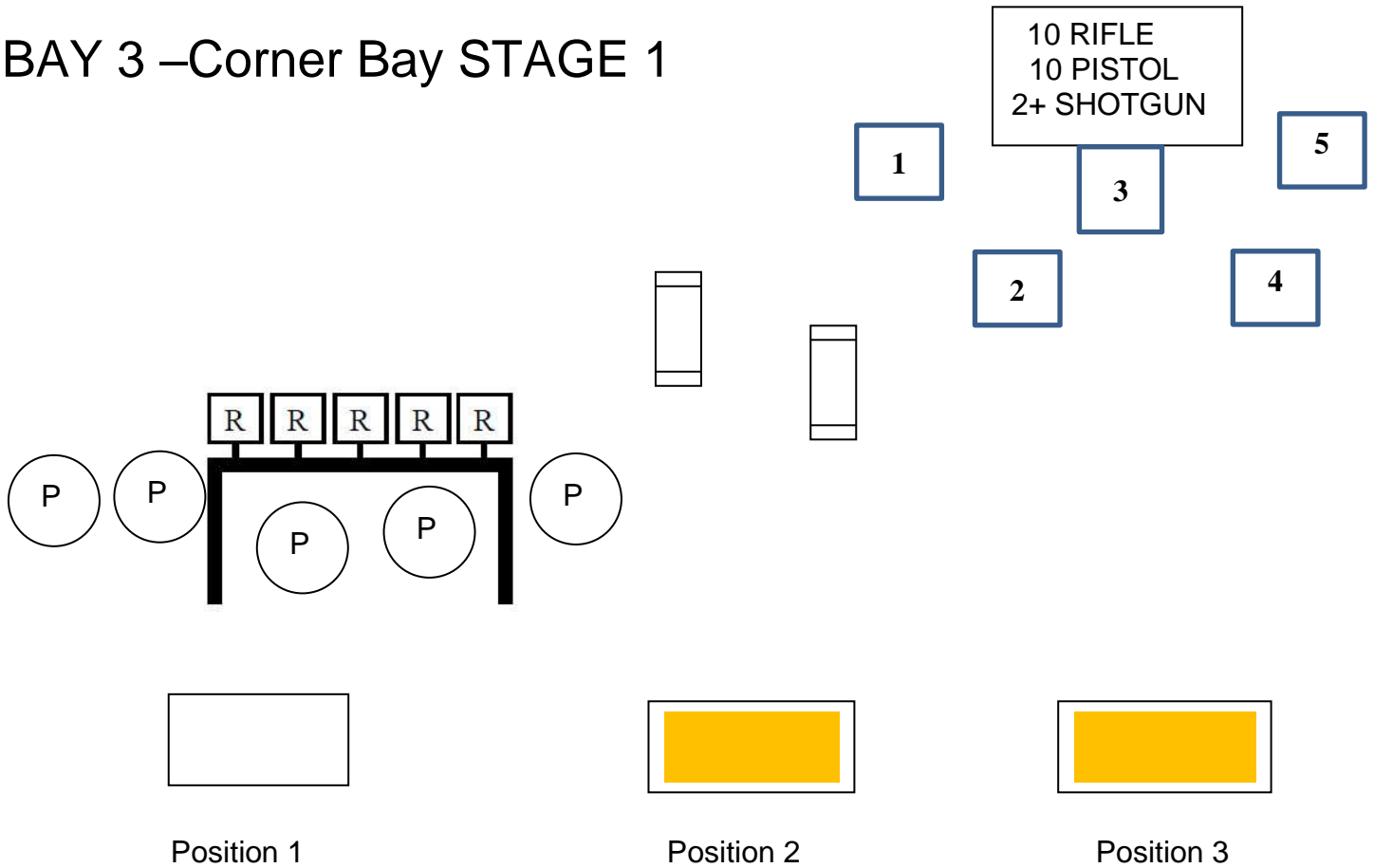

Start: At position 1 standing with one hand on a make believe bible and the other hand as taking an oath. Rifle loaded with 10 rounds and open, empty shotgun both staged anywhere safely. Two revolvers loaded with 5 rounds each, holstered..

At the buzzer, From POS 1 with revolvers engage the 5 black plates on the rack and the five “P” targets ***once each***. Targets may be shot in any order. .Move to Position 3 and with rifle engage the 5 rifle targets in the following order 1 On 3, 2 on 2, 2 on 1, 1 on 3, 2 on 4, 2 on 5 . Move to Position 2 and with shotgun engage the two “S” targets. THEN make up any standing plates with the shotgun by engaging the rifle target 1 once for each plate standing.

NOTE: Any knockdown plates left standing and not made up will be counted as misses.

BAY 3 –Corner Bay STAGE 2

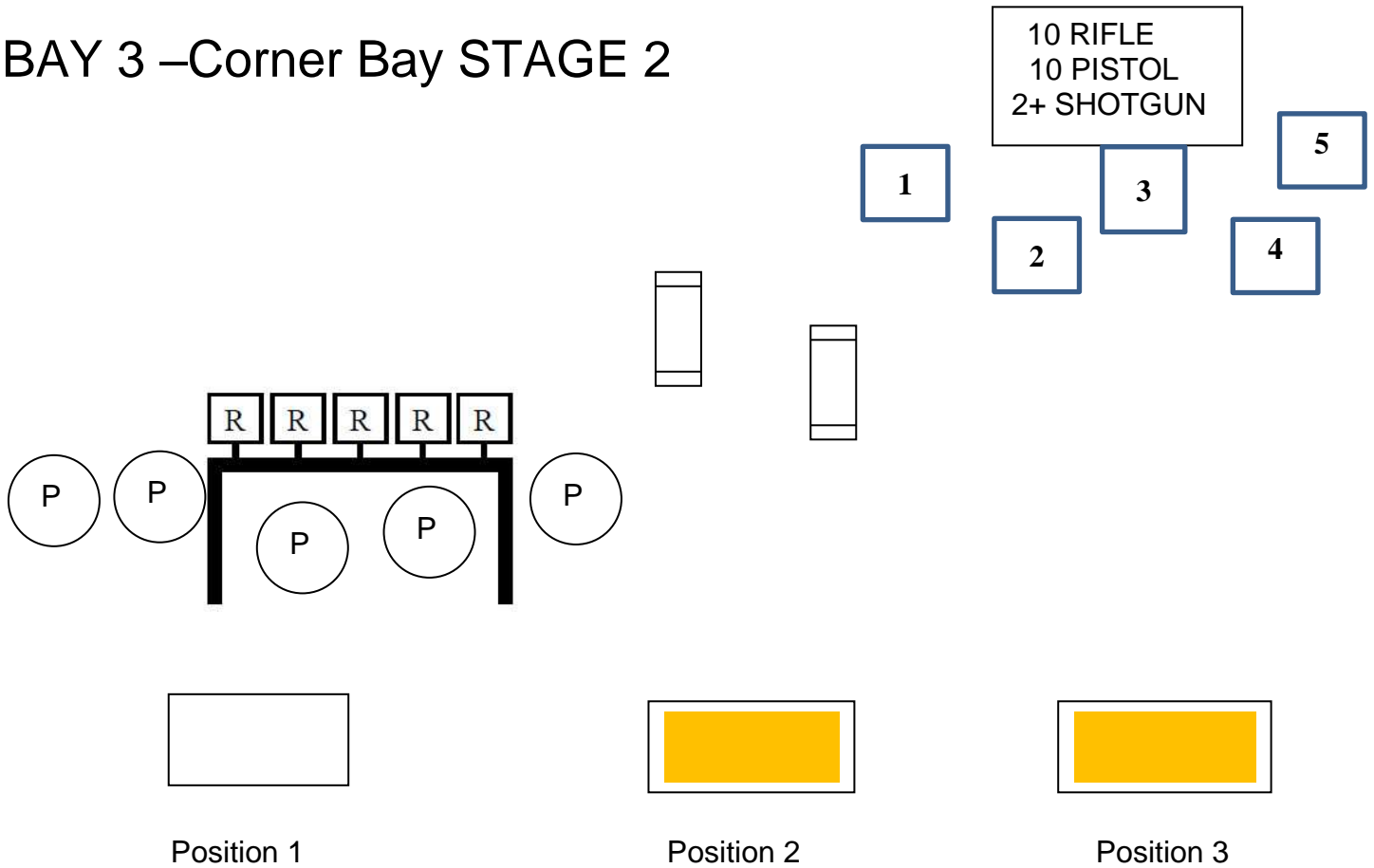

Start: At position 3 with rifle in cowboy pose (rifle on one hip and other hand on other hip). Rifle loaded with 10 rounds, open, empty shotgun staged anywhere safely. Two revolvers loaded with 5 rounds each, holstered..

At the buzzer, From Position 3 with rifle engage the 5 rifle targets with a double tap sweep from either end.

Move to Position 2 and with shotgun engage the two "S" targets.

Move to Position 1 and with revolvers engage the 6 plates on the rack until down and then any remaining rounds on the "P" target(s). Misses on the P target(s) and any plates left standing are misses. Each hit on a P target is a 1 second bonus.

BAY 5 -STAGE 3 -Restaurant

10 RIFLE
10 PISTOL
4+ SHOTGUN

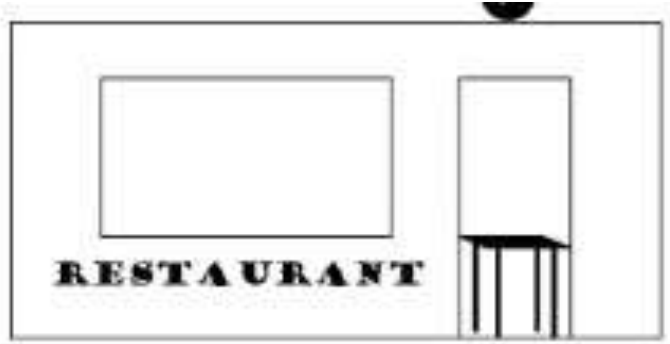
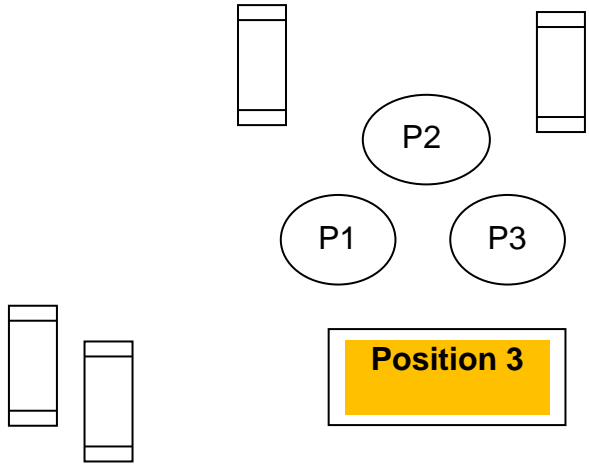
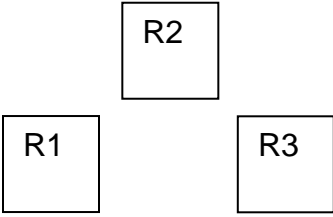

Position 1

Position 2

Start: Shooter standing at position 1 Rifle loaded with 10 rounds in hand. Open empty shotgun staged anywhere safely except at position 3. Pistols loaded with 5 rounds each holstered.

When ready say, **"Alive or dead – it's your choice"** Wait for the buzzer

At the buzzer, With Rifle engage R1-R3 at least three times each, any order. Make Rifle safe **vertically**. From POS 2 with shotgun engage the two close "Shotgun" targets. Move downrange to POS 3 and engage the far 2 shotgun targets, must go down. Then with revolvers engage P1-P3 as per the rifle instructions

BAY 5 -STAGE 4 -Restaurant

10 RIFLE
10 PISTOL
4+ SHOTGUN

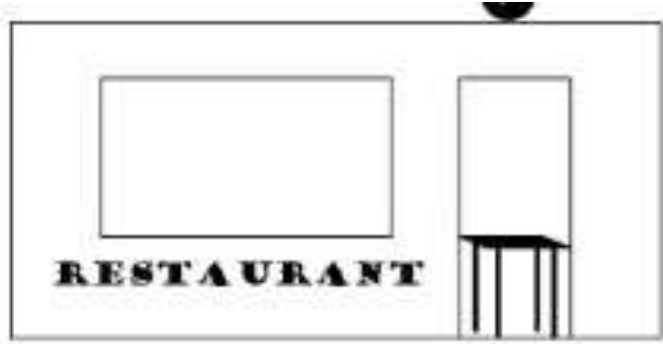
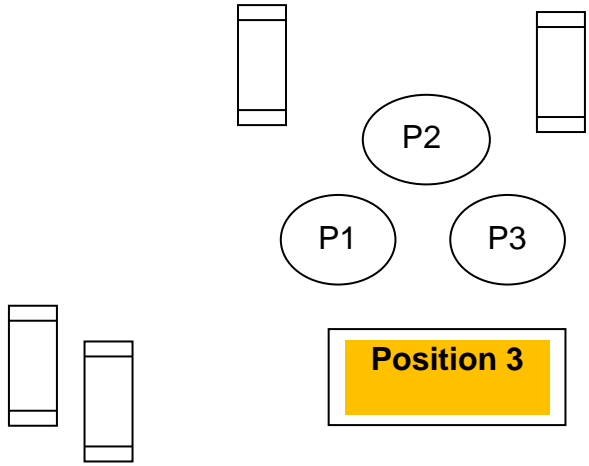
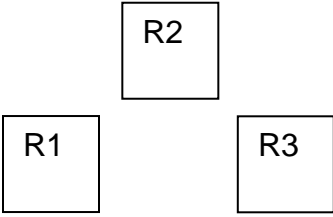

Position 1

Position 2

Start: Shooter standing at position 1 with hands on hat (or head). Rifle loaded with 10 rounds and open empty shotgun staged anywhere safely except at position 3. Pistols loaded with 5 rounds each holstered.

When ready say, ***"Dying aren't no choice"*** Wait for the buzzer

At the buzzer, With Rifle engage R1-R3 with a continuous Nevada sweep. Make Rifle safe ***vertically***. From POS 2 with shotgun engage the two close "Shotgun" targets. Move downrange to POS 3 and engage 2 far shotgun targets, must go down. Then with revolvers engage P1-P3 as per the rifle instructions

BAY 6 -STAGE 5 - Jail

10 RIFLE
10 PISTOL
4+ SHOTGUN

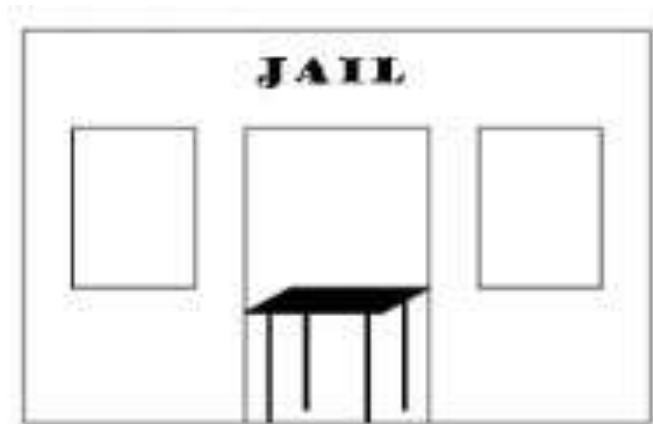
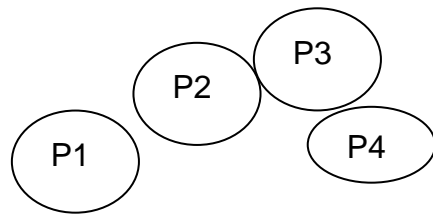
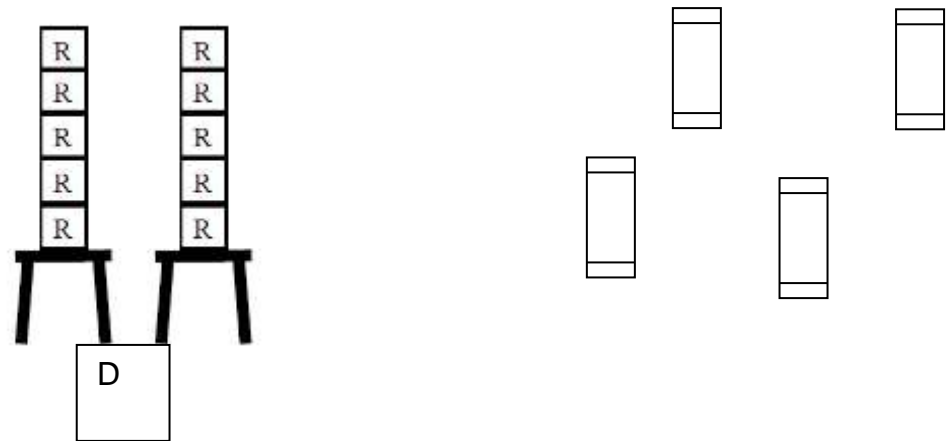

Position 1 Position 2 Position 3

Start: At Position 1 standing upright with hand(s) touching revolver(s), Two revolvers loaded with 5 rounds each, holstered, rifle loaded 10 and open empty shotgun staged anywhere safely.

At the buzzer engage the ten tombstone targets with the rifle.
Move to position 2 and with pistols engage the four pistol targets in a 2-3-3-2 sweep from the left.

Move to position three and engage the four shotgun targets until down then if any tombstone plates are standing you may take your shotgun back to position 1 and shoot the dump plate once for each plate left standing.

BAY 6 -STAGE 5 - Jail

10 RIFLE
10 PISTOL
4+ SHOTGUN

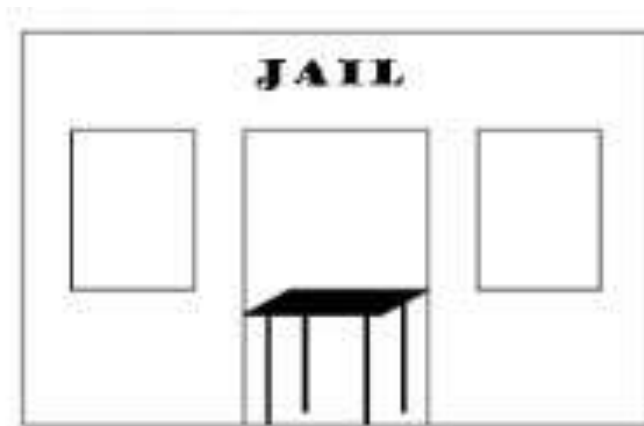
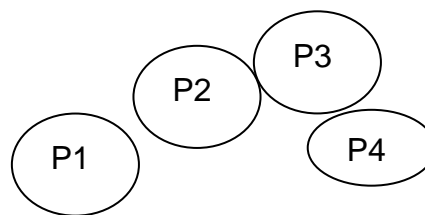
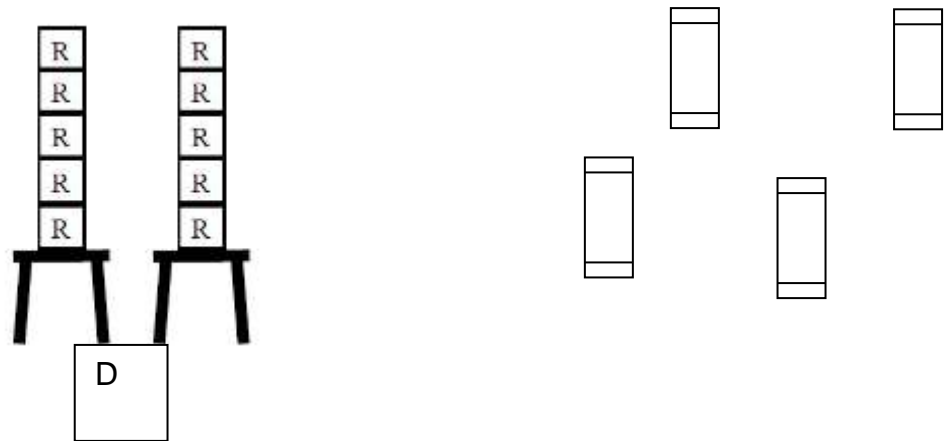

Position 1 Position 2 Position 3

Start: At Position 3 standing upright with shotgun in hand, Two revolvers loaded with 5 rounds each, holstered, rifle loaded 10 staged anywhere safely.

At the buzzer engage the four shotgun targets till down
Move to position 2 and with pistols engage the four pistol targets in a in a continuous Nevada sweep.

Move to position 1 and engage ten tombstones by alternating between the two racks. You may shoot the dump plate once for each plate left standing with any gun.