

*Bay 4, Stage 1: Restaurant*

- 10 Rifle
- 10 Pistol
- 4+ Shotgun

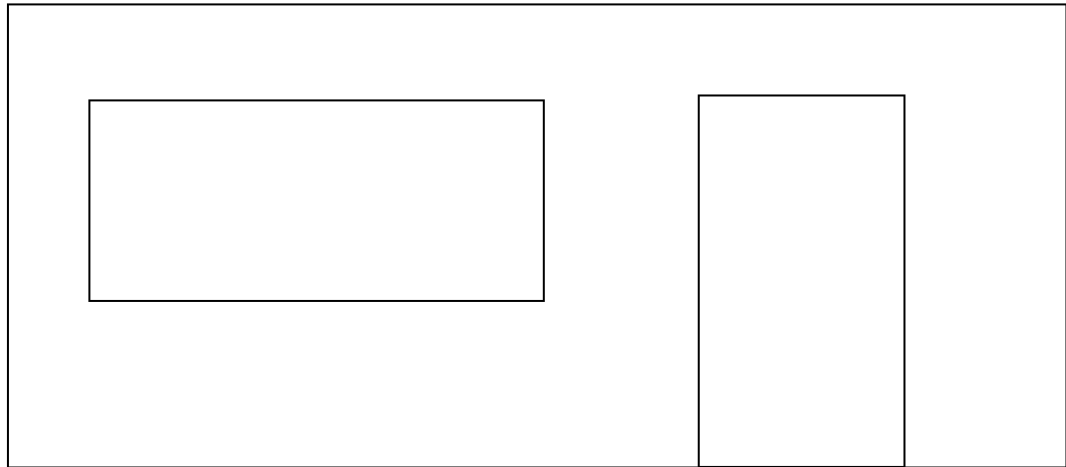
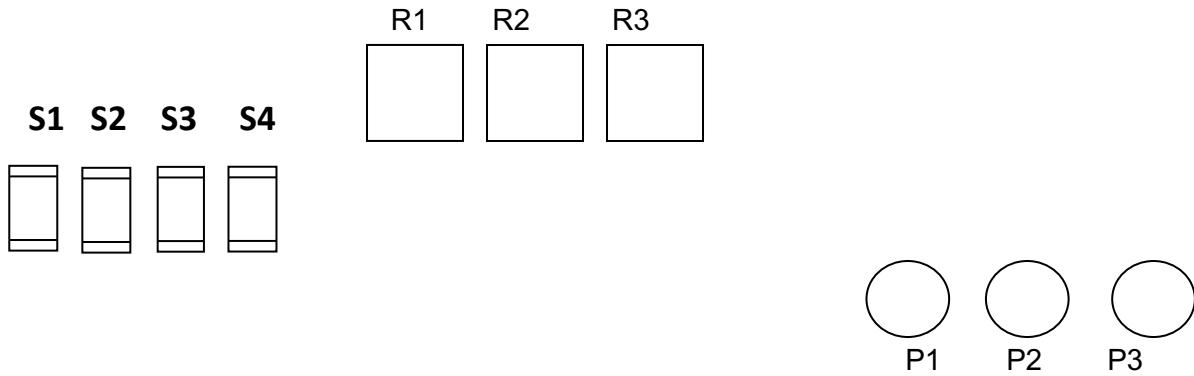

**Stage your rifle and shotgun in the window.**

**Standing in the doorway with hands on the table. At the beep engage the pistol targets in 2 separate Nevada sweeps, double tapping P1 for the second sweep for 10 rounds**

**Move to the window and engage the rifle targets in 2 separate Nevada sweeps, double tapping R1 for the second sweep for 10 rounds**

**Move to the right side of the Restaurant and engage the 4 shotgun targets MGD**

*Bay 4, Stage 2: Restaurant*

10 Rifle  
10 Pistol  
4+ Shotgun

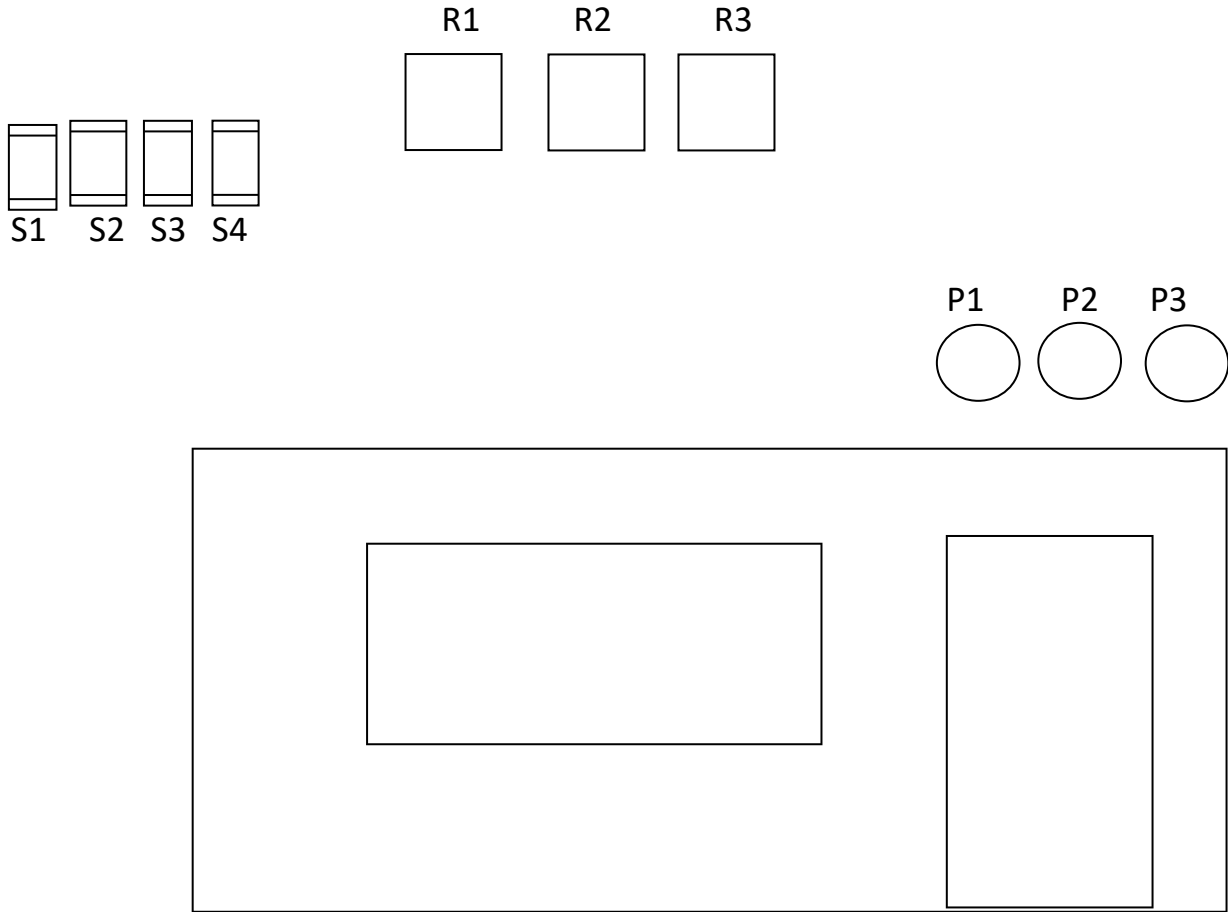

Stage your rifle in the window. Standing at the left side of the restaurant  
With shotgun in hands.

At the Beep engage the 4 shotgun targets MGD

Move to the window and engage the rifle targets from either end. R1-3, R2-4, R3-3, rounds. Move to the door.

Engage the Pistol Targets the same order as the rifle targets, starting on either end.

Steel 11 pistol

11 rifle

## Bay 7, Stage 5: Saloon

10 Rifle  
10 Pistol  
4+ Shotgun

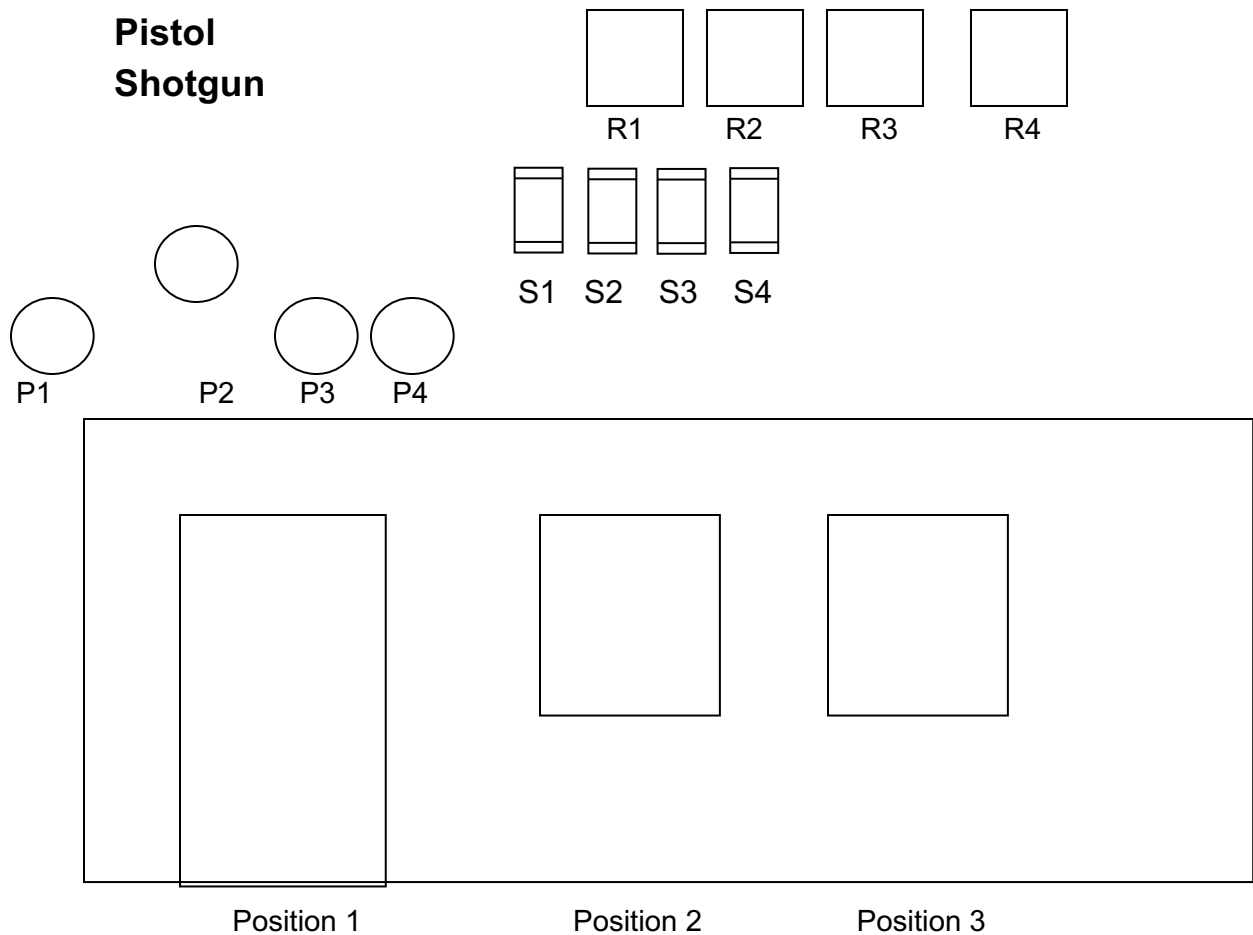

Standing at the back edge of the concrete, hands on hat in front of Position 1. Shooting order is shooters choice 1. Pistols loaded with 5 rounds each and holstered. Shotgun staged at Position 2, and Rifle staged at Position 3.

At the beep,

If with your pistols engage the "P" targets in a continuous Nevada Sweep starting from either end.

If with the shotgun engage the 4 shotgun targets outside/outside/inside/inside must go down.

If with the rifle engage the Rifle targets in a continuous Nevada Sweep starting from either end.

*Bay 7, Stage 6: Saloon*

- 10 Rifle
- 10 Pistol
- 4+ Shotgun

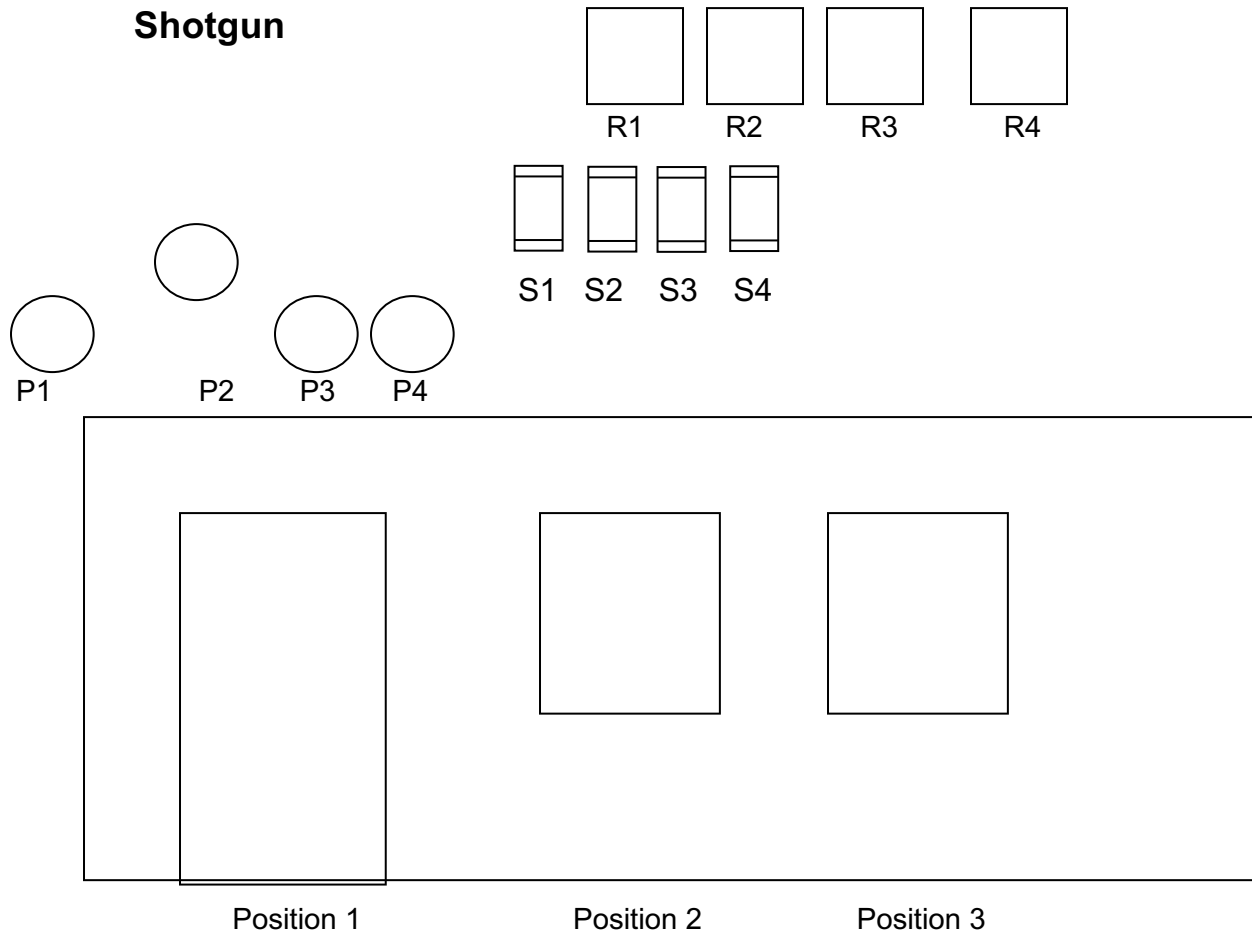

Standing at Position 3 in the “Cowboy” pose with Rifle. Pistols loaded with 5 rounds each and holstered. Shotgun staged anywhere.

At the Beep,

Engage the Rifle targets in a 4,1,1,4 Sweep starting from either end. Move to Position 2

Engage the 4 shotgun targets must go down.

With your pistols engage the “P” targets same as the rifle targets starting from either end 4,1,1,4. Can be shot from any position.

*Bay 6, Stage 3:*

*Jail*

10 Rifle

10 Pistol

4+ Shotgun

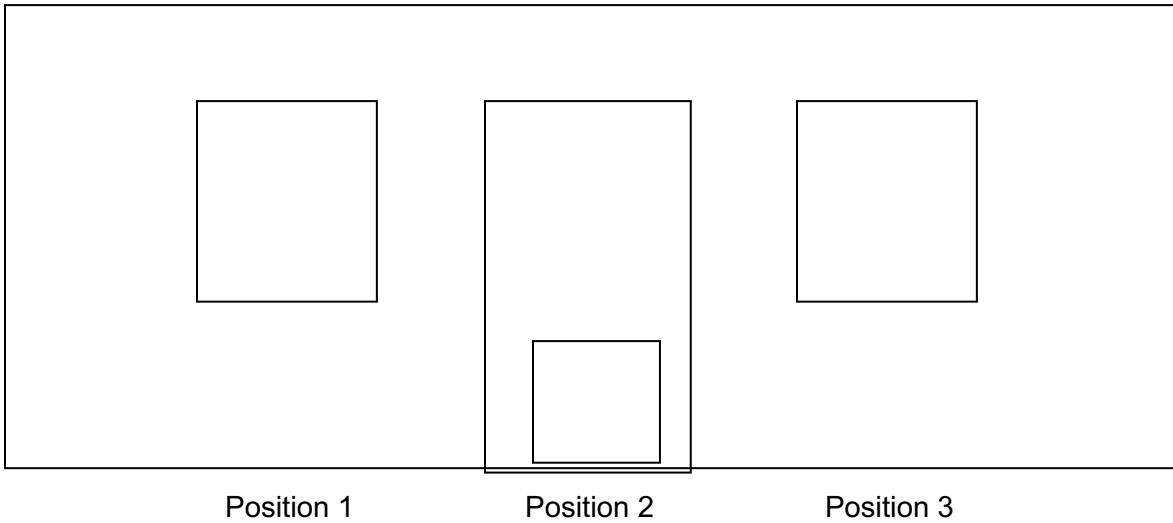
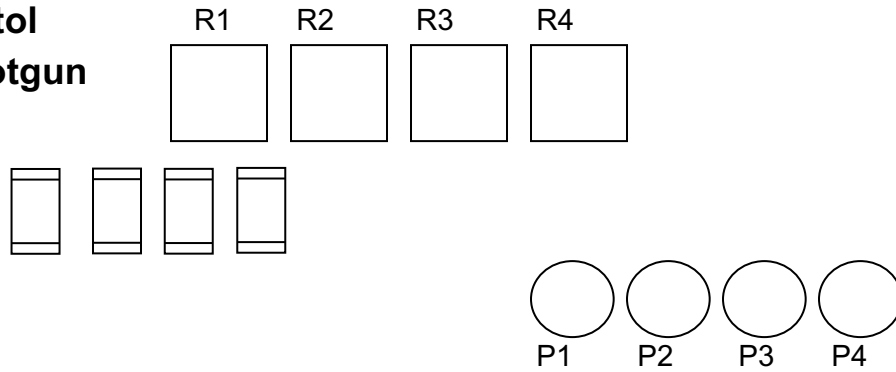

Standing at Position 2 with hands in low surrender. Pistols loaded with 5 rounds each and holstered. Stage the Rifle at Position 2. Shotgun staged anywhere.

At the Beep,

Engage the rifle targets from either end. R1-3, R2-2, R3-2, R4-3 rounds. Move to Position 1.

Engage the 4 shotgun targets, must go down. Move to Position 3.

Engage the Pistol Targets the same order as the rifle targets, starting on either end

*Bay 6, Stage 4: Jail*

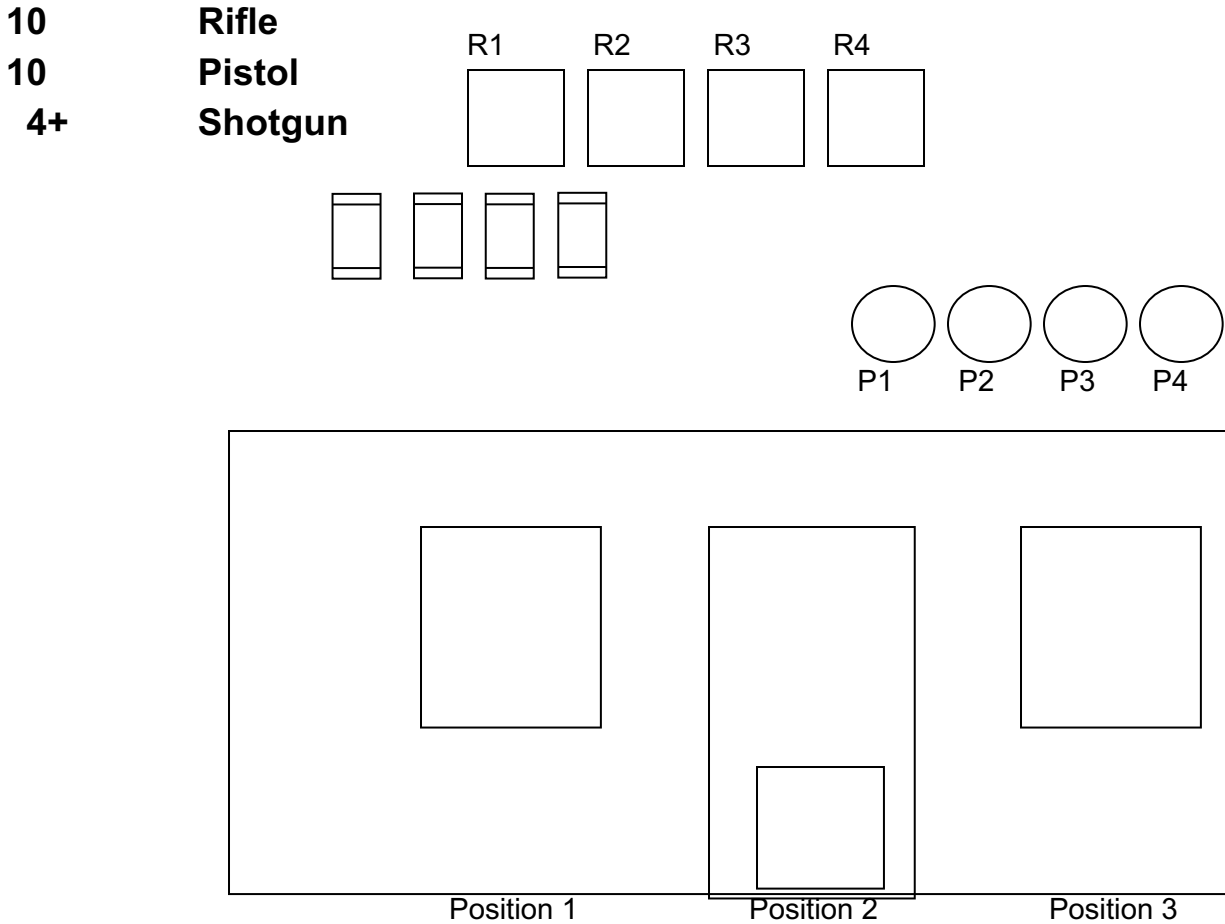

Standing at Position 1 with shotgun in Hand. Pistols loaded with 5 rounds each and holstered. Stage the Rifle at Position 2. At the beep.

Engage the 4 shotgun targets from right to left, must go down. Move to Position 2.

Engage the rifle targets in a 1,2,3,4 sequence from either end. R1-1, R2-2, R3-3, R4-4 rounds. Move to Position 3.

Engage the Pistol Targets the same as the rifle targets.